

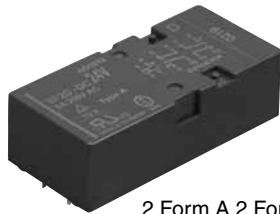

**Flat type safety relays
(double contact)**

SF RELAYS
Double contact type



2 Form A 2 Form B



4 Form A 4 Form B

RoHS compliant

FEATURES

- 1. High contact reliability**
High contact reliability is achieved through the use of a double contact.
- 2. Forced operation contacts**
N.O. and N.C. side contacts are connected through a card so that one interacts with the other in movement. In case of a contact welding, the other keeps a min. 0.5mm .020inch contact gap.
- 3. Independent operation contacts (4 Form A 4 Form B)**
There are 4 points of forced operation contacts. Each pair of contacts is free from the main armature and is independent from each other. So if a N.O. pair of contacts are welded, the other 3 N.O. contacts are not effected (operate properly) That enables to plan a circuit to detect welding or go back to the beginning condition.
- 4. Separated chamber structure**
N.O. and N.C. side contacts are put in each own space surrounded with a card and a body-separater. That prevents short circuit between contacts, which is caused by their springs welding or damaged.

- 5. High breakdown voltage**
High breakdown voltage 2,500 Vrms between contacts and coil.
- 6. High sensitivity**
Realizes thin shape and high sensitivity (500 mW nominal operating power) by utilizing high-efficiency polarized magnetic circuit with 4-gap balanced armature.
- 7. Complies with safety standards**
Standard products are UL, CSA, TÜV and SEV certified. Conform to European standards. TÜV certified. Complies with SUVA European standard.

TYPICAL APPLICATIONS

- 1. Industrial equipment such as presses and machine tools**
- 2. Elevators and other kinds of hoisting mechanisms, conveyor equipment.**

ORDERING INFORMATION

SF D -

Contact arrangement
2: 2 Form A 2 Form B
4: 4 Form A 4 Form B

Nominal coil voltage
DC 5, 12, 24, 48, 60V

Note: Certified by UL, CSA, TÜV and SEV

TYPES

| Contact arrangement | Nominal coil voltage | Part No. |
|---------------------|----------------------|------------|
| 2 Form A 2 Form B | 5V DC | SF2D-DC5V |
| | 12V DC | SF2D-DC12V |
| | 24V DC | SF2D-DC24V |
| | 48V DC | SF2D-DC48V |
| | 60V DC | SF2D-DC60V |
| 4 Form A 4 Form B | 5V DC | SF4D-DC5V |
| | 12V DC | SF4D-DC12V |
| | 24V DC | SF4D-DC24V |
| | 48V DC | SF4D-DC48V |
| | 60V DC | SF4D-DC60V |

Standard packing: Carton: 20 pcs.; Case: 200 pcs.

SF Double contact type

RATING

1. Coil data

| Contact arrangement | Nominal coil voltage | Pick-up voltage (at 20°C 68°F) | Drop-out voltage (at 20°C 68°F) | Nominal coil current [±10%] (at 20°C 68°F) | Coil resistance [±10%] (at 20°C 68°F) | Nominal operating power (at 20°C 68°F) | Max. applied voltage (at 20°C 68°F) |
|---------------------|----------------------|---|---|--|---------------------------------------|--|-------------------------------------|
| 2 Form A 2 Form B | 5V DC | 75%V or less of nominal voltage (Initial) | 10%V or more of nominal voltage (Initial) | 100mA | 50Ω | 500mW | 120%V of nominal voltage |
| | 12V DC | | | 41.7mA | 288Ω | | |
| | 24V DC | | | 20.8mA | 1,152Ω | | |
| | 48V DC | | | 10.4mA | 4,608Ω | | |
| | 60V DC | | | 8.3mA | 7,200Ω | | |
| 4 Form A 4 Form B | 5V DC | 75%V or less of nominal voltage (Initial) | 15%V or more of nominal voltage (Initial) | 100mA | 50Ω | 500mW | |
| | 12V DC | | | 41.7mA | 288Ω | | |
| | 24V DC | | | 20.8mA | 1,152Ω | | |
| | 48V DC | | | 10.4mA | 4,608Ω | | |
| | 60V DC | | | 8.3mA | 7,200Ω | | |

2. Specifications

| Characteristics | Item | Specifications | |
|----------------------------|---|---|---|
| Contact | Arrangement | 2 Form A 2 Form B 4 Form A 4 Form B | |
| | Contact resistance (Initial) | Max. 30 mΩ (By voltage drop 6 V DC 1A) | |
| | Contact material | Au-flashed AgSnO ₂ type | |
| Rating | Nominal switching capacity (resistive load) | 6A 250V AC, 6A 30V DC | |
| | Max. switching power (resistive load) | 1,500VA 180W | |
| | Max. switching voltage | 440V AC, 30V DC | |
| | Max. switching current | 6A | |
| | Nominal operating power | 500mW | |
| | Min. switching capacity (Reference value)*1 | 100mA 5V DC | |
| Electrical characteristics | Insulation resistance (Initial) | Min. 1,000MΩ (at 500V DC) Measurement at same location as "Breakdown voltage" section. | |
| | Breakdown voltage (Initial) | Between open contacts | 1,300 Vrms for 1min. (Detection current: 10mA) |
| | | Between contact sets | 2,500 Vrms for 1min. (Detection current: 10mA) |
| | | Between contact and coil | 2,500 Vrms for 1min. (Detection current: 10mA) |
| | Temperature rise (coil) (at 20° 68°F) | Max. 45°C 113°F (By resistive method, nominal voltage applied to the coil; contact carrying current: 6A) | |
| | Operate time | Max. 30ms (Nominal voltage applied to the coil, excluding contact bounce time.) | |
| | Release time | Max. 15ms (Nominal voltage applied to the coil, excluding contact bounce time.) (without diode) | |
| Mechanical characteristics | Shock resistance | Functional | Min. 294 m/s ² (Half-wave pulse of sine wave: 11 ms; detection time: 10μs) |
| | | Destructive | Min. 980 m/s ² (Half-wave pulse of sine wave: 6 ms) |
| | Vibration resistance | Functional | 10 to 55 Hz at double amplitude of 2 mm (Detection time: 10μs) |
| | | Destructive | 10 to 55 Hz at double amplitude of 2 mm |
| Expected life | Mechanical | Min. 10 ⁷ (at 180 times/min.) | |
| | Electrical | Min. 10 ⁵ (at 20 times/min.) | |
| Conditions | Conditions for operation, transport and storage*2 | Ambient temperature: -40°C to +70°C -40°F to +158°F Humidity: 5 to 85% R.H. (Not freezing and condensing at low temperature) | |
| | Max. Operating speed | 180 times/min. | |
| Unit weight | | Approx. 38g 1.34oz Approx. 47g 1.66oz | |

Notes: *1. This value can change due to the switching frequency, environmental conditions and desired reliability level, therefore it is recommended to check this with the actual load.

*2. The upper limit of the ambient temperature is the maximum temperature that can satisfy the coil temperature rise value. Refer to Usage, transport and storage conditions in NOTES.

REFERENCE DATA

1. Operate/release time (without diode)

Tested sample: SF2D-DC24V (2 Form A 2 Form B)
Quantity: n = 20

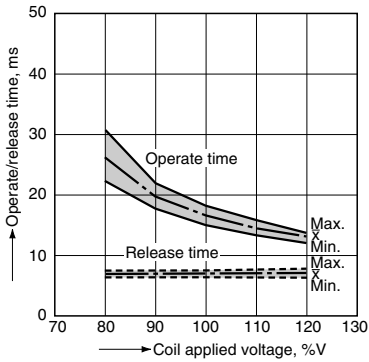

2. Temperature rise

Tested sample: SF4D-DC24V (4 Form A 4 Form B)
Quantity: n = 6
Coil applied voltage: 100%V, 120%V
Contact carry current: 6A

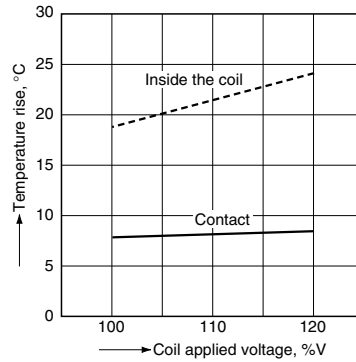

3. Ambient temperature characteristics

Tested sample: SF4D-DC24V (4 Form A 4 Form B)
Quantity: n = 6

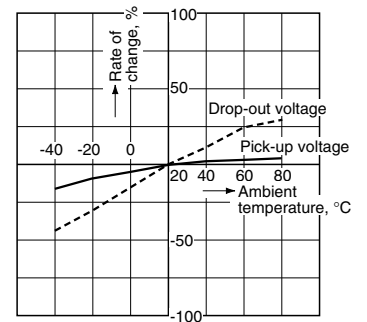

DIMENSIONS (mm inch)

The CAD data of the products with a **CAD Data** mark can be downloaded from: <http://industrial.panasonic.com/ac/e/>

1. 2 Form A 2 Form B

CAD Data



External dimensions

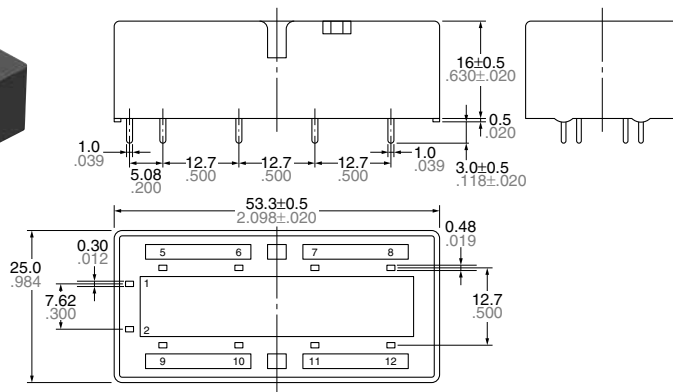

General tolerance: $\pm 0.3 \pm 0.12$

Schematic (Bottom view)

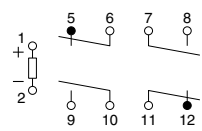

PC board pattern (Bottom view)

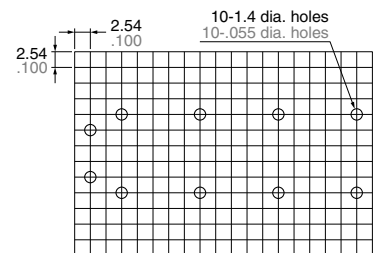

Tolerance: $\pm 0.1 \pm 0.004$

2. 4 Form A 4 Form B

CAD Data



External dimensions

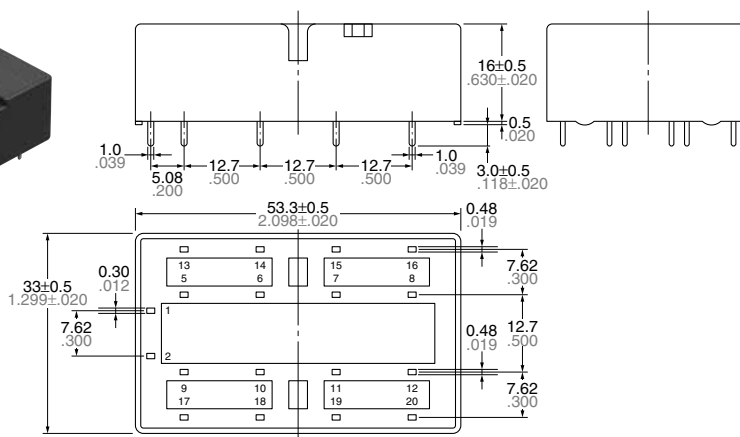

General tolerance: $\pm 0.3 \pm 0.12$

Schematic (Bottom view)

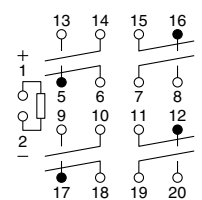

PC board pattern (Bottom view)

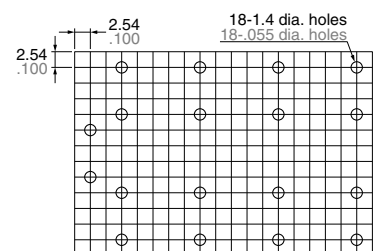

Tolerance: $\pm 0.1 \pm 0.004$

SF Double contact type

SAFETY STANDARDS

| UL/C-UL (Recognized) | | TÜV (Certified) | | SEV | |
|----------------------|-------------------------|--|-------------------------|----------|-------------------------|
| File No. | Contact rating | File No. | Rating | File No. | Contact rating |
| E120782* | 6A 250V AC 6A 24V DC | 968 EZ 116.03/10 (SF2D) 968 EZ 116.02/09 (SF4D) | 3A 24V DC 6A 250V AC | 12.0520 | 6A 24V DC 6A 250V AC |

* CSA standard: Certified by C-UL

SAFETY STRUCTURE OF SF RELAYS

This SF relay design ensures that subsequent operations shut down and can automatically return to a safe state when the SF relay suffers overloading and other circuit abnormalities

(unforeseen externally caused circuit or device breakdowns, end of life incidents, and noise, surge, and environmental influences) owing to contact welding, spring fusion or, in the worst-case

scenario, relay breakdown (coil rupture, faulty operation, faulty return, and fatigue and breakage of the operating spring and return spring), and even in the event of end of life.

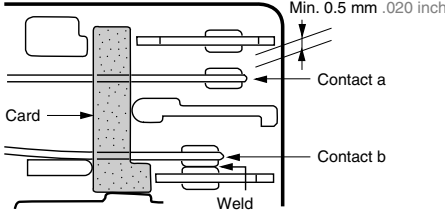
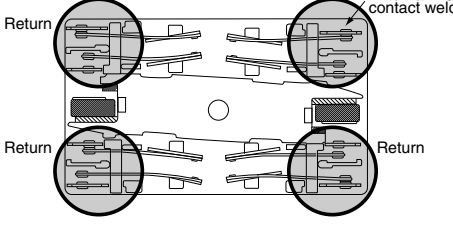
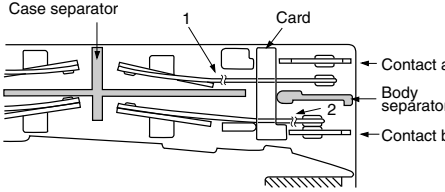
| | Structure | Operation |
|---|--|--|
| 1. Forced operation method (2 Form A 2 Form B, 4 Form A 4 Form B types) |  <p>The two contacts "a" and "b" are coupled with the same card. The operation of each contact is regulated by the movement of the other contact.</p> | <p>Even when one contact is welded closed, the other maintains a gap of greater than 0.5 mm .020 inch.</p> <p>In the diagram on the left, the lower contact "b" have welded but the upper contact "a" maintain a gap of greater than 0.5 mm .020 inch. Subsequent contact movement is suspended and the weld can be detected</p> |
| 2. Independent operation method (4 Form A 4 Form B type) |  <p>None of four contacts are held in position by the armature. Even though one of the external N.O. contacts has welded, the other three contacts have returned owing to the de-energizing of the coil.</p> | <p>Enables design of safety circuits that allow weld detection and return at an early stage.</p> <p>As shown at the top right of the diagram on the left, if the external N.O. contact welds, a 0.5 mm .020 inch gap is maintained. Each of the other contacts returns to N.O. because the coil is no longer energized.</p> |
| 3. Separate chamber method (2 Form A 2 Form B, 4 Form A 4 Form B types) |  <p>In independent chambers, the contacts "a" and "b" are kept apart by a body/case separator or by the card itself.</p> | <p>Prevents shorting and fusing of springs and spring failure owing to short-circuit current.</p> <p>As shown on the diagram on the left, even if the operating springs numbered 1 and 2 there is no shorting between "a" and "b" contacts.</p> |
| 4. 2 Form A 2 Form B contact 4 Form A 4 Form B contact | Structure with independent COM contact of 2 Form A 2 Form B and 4 Form A 4 Form B contacts. | Independent COM enables differing pole circuit configurations. This makes it possible to design various kinds of control circuits and safety circuits. |

THE OPERATION OF SF RELAYS (when contacts are welded)

SF relays work to maintain a normal operating state even when the contact welding occur by overloading or short-circuit currents. It is easy to make weld detection circuits and safety circuits in the design to ensure safety even if contacts weld.

1) 2 Form A 2 Form B type

Form "b" Contact Weld

If the form "b" contact (No. 1 and 3) welds, the armature becomes non-operational, the contact gaps at the three form "a" contacts are maintained at greater than 0.5 mm .020 inch. Reliable isolation is thus ensured.

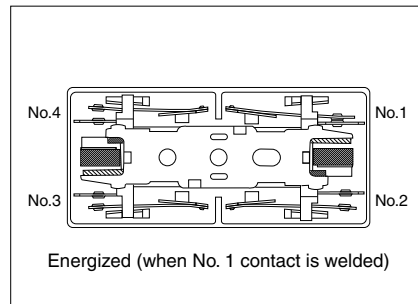
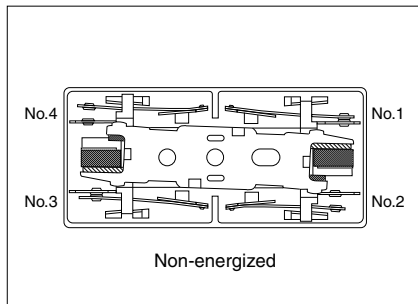

Example: If the No. 1 contact welds

Each of the three form "a" contacts (No. 2 and 4) maintain a gap of greater than 0.5 mm .020 inch.

Form "a" Contact Weld

When the form "a" contacts (No. 2 or 4) weld, the armature remains in a non-returned state and the contact gap at the two form "b" contact is maintained at greater than 0.5 mm .020 inch. Reliable isolation is thus ensured.

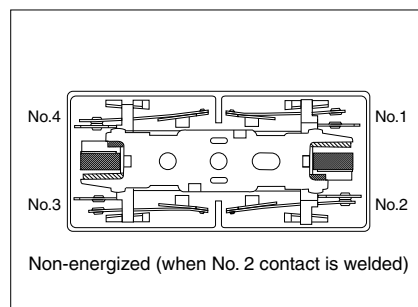
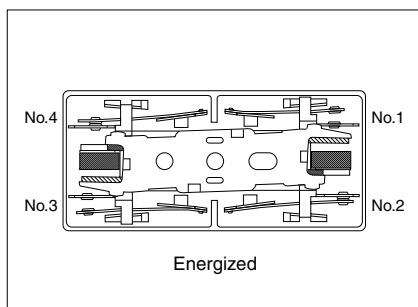

Example: If the No. 2 contact welds.

The two form "b" contact (No. 1 or 3) maintains a gap of greater than 0.5 mm .020 inch.

Contact Operation Table

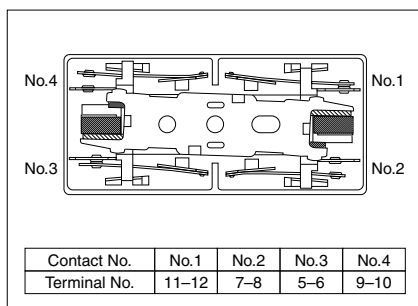

The table below shows the state of the other contacts when the current through the welded form "a" contact is 0 V and the rated voltage is applied through the form "b" contact.

| | | State of other contacts | | | |
|---------------------|---|-------------------------|------|------|------|
| | | 1 | 2 | 3 | 4 |
| Welded terminal No. | 1 | | >0.5 | >0.5 | >0.5 |
| | 2 | >0.5 | | >0.5 | |
| | 3 | >0.5 | >0.5 | | >0.5 |
| | 4 | >0.5 | | >0.5 | |

>0.5: contact gap is kept at min. 0.5 mm .020 inch
Empty cells: either closed or open

* Contact gaps are shown at the initial state.
If the contacts change state owing to loading/breaking it is necessary to check the actual loading.

SF Double contact type

2) 4 Form A 4 Form B type

Internal Contacts Weld

When internal contacts (No. 2, No. 3, No. 6 or No. 7) are welded, the armature becomes non-operational and the four form "a" contact gaps are maintained at 0.5 mm .020inch or greater. Reliable cut-off is thus ensured.

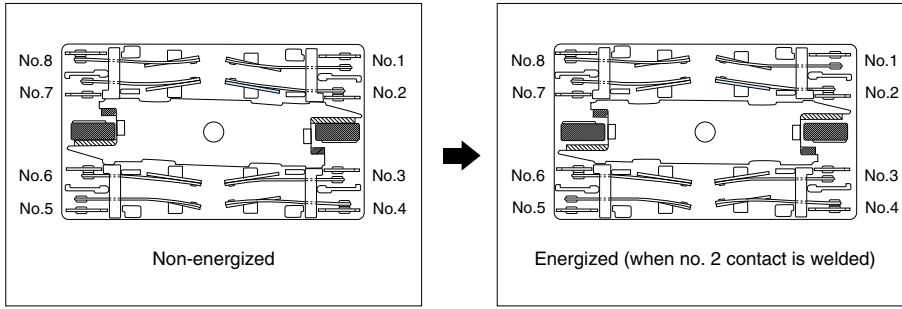

Example: If the No. 2 contact welds. Each of the four form "a" contacts (No. 1, 3, 5, and 7) maintains a gap of greater than 0.5 mm .020 inch.

External Contacts Weld

When external contacts (No. 1, No. 4, No. 5 or No. 8) are welded, gaps of 0.5 mm .020inch and greater are maintained between adjacent contacts and other contacts operate normally by the coil being non-energized.

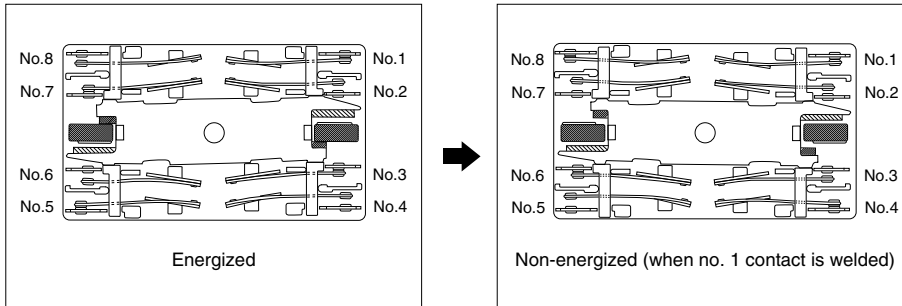

Example 1: If the No. 1 contact welds. The adjacent No. 2 contact maintains a gap of greater than 0.5 mm .020 inch. The other contacts, because the coil is not energized, return to their normal return state; each of form "a" contacts (No. 3, 5, and 7) maintains a contact gap of greater than 0.5 mm .020 inch; each of the form "b" contacts (No. 4, 6, and 8) return to a closed state.

Example 2:
If external connections are made in series. Even if one of the contacts welds, the other contacts operate independently and the contact gaps are maintained at greater than 0.5 mm .020 inch.

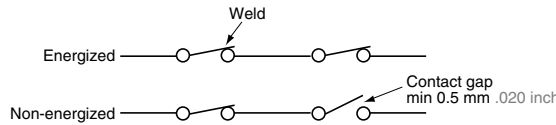

Contact Operation Table

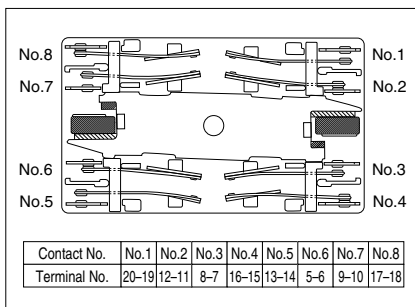

The table below shows the state of the other contacts when the current through the welded form "a" contact is 0 V and the rated voltage is applied through the form "b" contact.

| Contact No. | State of other contacts | | | | | | | |
|-------------|-------------------------|------|------|------|------|------|------|------|
| | 1 | 2 | 3 | 4 | 5 | 6 | 7 | 8 |
| 1 | 1 | >0.5 | >0.5 | ≠ | >0.5 | ≠ | >0.5 | ≠ |
| 2 | >0.5 | 1 | >0.5 | | >0.5 | | >0.5 | |
| 3 | | >0.5 | 1 | >0.5 | | >0.5 | | >0.5 |
| 4 | ≠ | >0.5 | >0.5 | 1 | ≠ | >0.5 | ≠ | >0.5 |
| 5 | >0.5 | | >0.5 | ≠ | 1 | >0.5 | >0.5 | ≠ |
| 6 | >0.5 | | >0.5 | | >0.5 | 1 | >0.5 | |
| 7 | | >0.5 | | >0.5 | | >0.5 | 1 | >0.5 |
| 8 | >0.5 | >0.5 | ≠ | >0.5 | ≠ | >0.5 | >0.5 | 1 |

>0.5: contact gap is kept at min. 0.5 mm .020 inch
≠: contact closed
Empty cells: either closed or open

* Contact gaps are shown at the initial state. If the contacts change state owing to loading/breaking it is necessary to check the actual loading.

NOTES

1. For cautions for use, please read "General Application Guidelines".

GUIDELINES FOR POWER, HIGH-CAPACITY DC CUT OFF AND SAFETY RELAYS USAGE

For cautions for use, please read "GUIDELINES FOR RELAY USAGE".

https://industrial.panasonic.com/ac/e/control/relay/cautions_use/index.jsp

Precautions for Coil Input

■ Long term current carrying

A circuit that will be carrying a current continuously for long periods without relay switching operation. (circuits for emergency lamps, alarm devices and error inspection that, for example, revert only during malfunction and output warnings with form B contacts) Continuous, long-term current to the coil will facilitate deterioration of coil insulation and characteristics due to heating of the coil itself.

For circuits such as these, please use a magnetic-hold type latching relay. If you need to use a single stable relay, use a sealed type relay that is not easily affected by ambient conditions and make a failsafe circuit design that considers the possibility of contact failure or disconnection.

■ DC Coil operating power

Steady state DC current should be applied to the coil. The wave form should be rectangular. If it includes ripple, the ripple factor should be less than 5%.

However, please check with the actual circuit since the electrical characteristics may vary. The rated coil voltage should be applied to the coil and the set/reset pulse time of latching type relay differs for each relays, please refer to the relay's individual specifications.

■ Coil connection

When connecting coils of polarized relays, please check coil polarity (+,-) at the internal connection diagram (Schematic). If any wrong connection is made, it may cause unexpected malfunction, like abnormal heat, fire and so on, and circuit do not work. Avoid impressing voltages to the set coil and reset coil at the same time.

■ Maximum allowable voltage and temperature rise

Proper usage requires that the rated coil voltage be impressed on the coil. Note, however, that if a voltage greater than or equal to the maximum continuous voltage is impressed on the coil, the coil may burn or its layers short due to the temperature rise. Furthermore, do not exceed the usable ambient temperature range listed in the catalog.

■ Operate voltage change due to coil temperature rise (Hot start)

In DC relays, after continuous passage of current in the coil, if the current is turned OFF, then immediately turned ON again, due to the temperature rise in the coil, the pick-up voltage will become somewhat higher. Also, it will be the same as using it in a higher temperature atmosphere. The resistance/temperature relationship for copper wire is about 0.4% for 1°C, and with this ratio the coil resistance increases. That is, in order to operate of the relay, it is necessary that the voltage be higher than the pick-up voltage and the pick-up voltage rises in accordance with the increase in the resistance value. However, for some polarized relays, this rate of change is considerably smaller.

Ambient Environment

● Usage, Transport, and Storage Conditions

During usage, storage, or transportation, avoid locations subjected to direct sunlight and maintain normal temperature, humidity and pressure conditions.

● Temperature/Humidity/Pressure

When transporting or storing relays while they are tube packaged, there are cases the temperature may differ from the allowable range. In this case be sure to check the individual specifications.

Also allowable humidity level is influenced by temperature, please check charts shown below and use relays within mentioned conditions. (Allowable temperature values differ for each relays, please refer to the relay's individual specifications.)

1) Temperature:

The tolerance temperature range differs for each relays, please refer to the relay's individual specifications

2) Humidity: 5 to 85 % RH

3) Pressure: 86 to 106 kPa

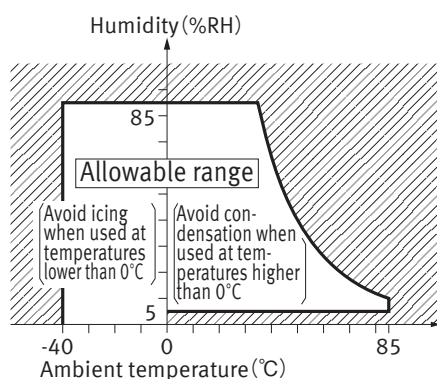

● Dew condensation

Condensation occurs when the ambient temperature drops suddenly from a high temperature and humidity, or the relay is suddenly transferred from a low ambient temperature to a high temperature and humidity. Condensation causes the failures like insulation deterioration, wire disconnection and rust etc.

Panasonic Corporation does not guarantee the failures caused by condensation.

The heat conduction by the equipment may accelerate the cooling of device itself, and the condensation may occur.

Please conduct product evaluations in the worst condition of the actual usage. (Special attention should be paid when high temperature heating parts are close to the device. Also please consider the condensation may occur inside of the device.)

● Icing

Condensation or other moisture may freeze on relays when the temperature become lower than 0°C. This icing causes the sticking of movable portion, the operation delay and the contact conduction failure etc. Panasonic Corporation does not guarantee the failures caused by the icing.

The heat conduction by the equipment may accelerate the cooling of relay itself and the icing may occur. Please conduct product evaluations in the worst condition of the actual usage.

● Low temperature and low humidity

The plastic becomes brittle if the switch is exposed to a low temperature, low humidity environment for long periods of time.

● High temperature and high humidity

Storage for extended periods of time (including transportation periods) at high temperature or high humidity levels or in atmospheres with organic gases or sulfide gases may cause a sulfide film or oxide film to form on the surfaces of the contacts and/or it may interfere with the functions. Check out the atmosphere in which the units are to be stored and transported.

GUIDELINES FOR POWER, HIGH-CAPACITY DC CUT OFF AND SAFETY RELAYS USAGE

●Package

In terms of the packing format used, make every effort to keep the effects of moisture, organic gases and sulfide gases to the absolute minimum.

●Silicon

When a source of silicone substances (silicone rubber, silicone oil, silicone coating materials and silicone filling materials etc.) is used around the relay, the silicone gas (low molecular siloxane etc.) may be produced.

This silicone gas may penetrate into the inside of the relay. When the relay is kept and used in this condition, silicone compound may adhere to the relay contacts which may cause the contact failure. Do not use any sources of silicone gas around the relay (Including plastic seal types).

●NOx Generation

When relay is used in an atmosphere high in humidity to switch a load which easily produces an arc, the NOx created by the arc and the water absorbed from outside the relay combine to produce nitric acid. This corrodes the internal metal parts and adversely affects operation. Avoid use at an ambient humidity of 85%RH or higher (at 20°C). If use at high humidity is unavoidable, please contact our sales representative.

Others

■Cleaning

- 1) Although the environmentally sealed type relay (plastic sealed type, etc.) can be cleaned, avoid immersing the relay into cold liquid (such as cleaning solvent) immediately after soldering. Doing so may deteriorate the sealing performance.
- 2) Cleaning with the boiling method is recommended(The temperature of cleaning liquid should be 40°C or lower).
Avoid ultrasonic cleaning on relays. Use of ultrasonic cleaning may cause breaks in the coil or slight sticking of the contacts due to ultrasonic energy.

Please refer to **"the latest product specifications"** when designing your product.

•Requests to customers:

<https://industrial.panasonic.com/ac/e/salespolicies/>

Please contact

Panasonic Corporation

Electromechanical Control Business Division

■ 1006, Oaza Kadoma, Kadoma-shi, Osaka 571-8506, Japan
industrial.panasonic.com/ac/e/

Panasonic®

©Panasonic Corporation 2019